

# Basics – I. Positional astronomy

Dave Kilkenny

NON SEQUITUR

by WILEY

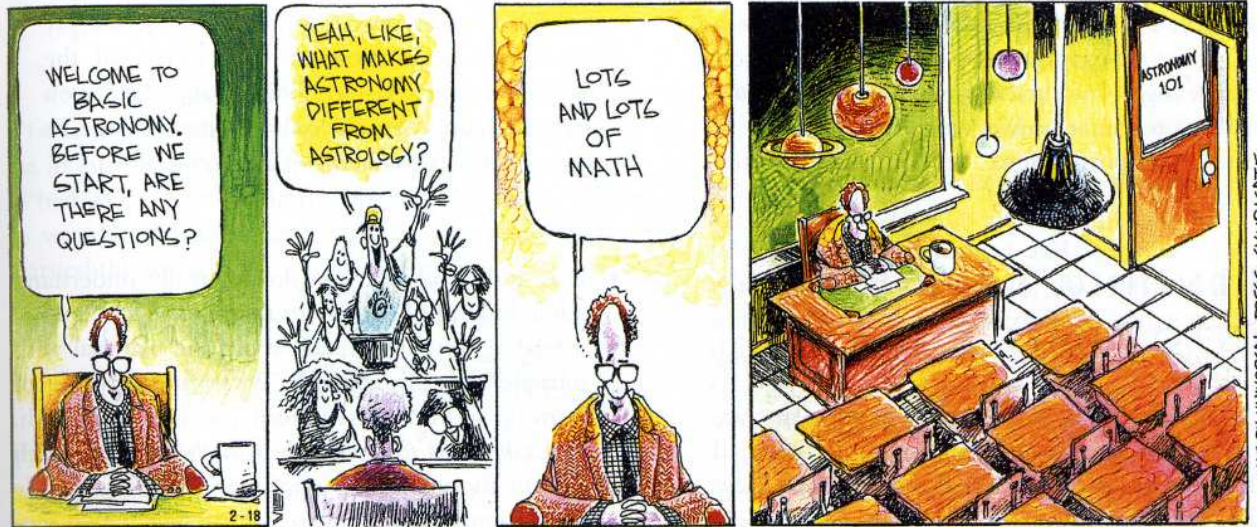

# Contents

<b>1</b>	<b>Co-ordinate systems</b>	<b>3</b>
1.1	Elements of spherical astronomy . . . . .	3
1.1.1	Circles . . . . .	3
1.1.2	Example: Latitude & Longitude . . . . .	4
1.1.3	Spherical angles and triangles . . . . .	5
1.1.4	Small circles . . . . .	6
1.1.5	The sky . . . . .	6
1.2	Horizontal or altitude and azimuthal (“alt-az”) co-ordinates . . . . .	7
1.3	Hour angle and Declination (“First Equatorial”) co-ordinates . . . . .	8
1.4	Right Ascension and Declination (or “Second Equatorial”) co-ordinates . . . . .	10
1.4.1	Sidereal time . . . . .	11
1.4.2	Conversion between horizontal and equatorial co-ordinates . . . . .	13
1.5	Ecliptic co-ordinates . . . . .	14
1.6	Galactic co-ordinates . . . . .	16
<b>2</b>	<b>Effects on apparent celestial positions</b>	<b>17</b>
2.1	Precession and Nutation . . . . .	18
2.1.1	Luni-solar precession . . . . .	18
2.1.2	Planetary precession . . . . .	19
2.1.3	Nutation . . . . .	19
2.2	Parallax . . . . .	20
2.2.1	Geocentric or diurnal (daily) parallax . . . . .	20
2.2.2	Annual parallax . . . . .	22
2.3	Proper motion . . . . .	22
2.4	The aberration of starlight . . . . .	23
2.4.1	Comparison between the effects of parallax and aberration . . . . .	25
2.5	Atmospheric refraction . . . . .	25
2.6	Atmospheric dispersion . . . . .	28

# 1 Co-ordinate systems

## 1.1 Elements of spherical astronomy

From the point-of-view of positional astronomy – determining the positions and changes of positions of stars (eg. to measure parallax, proper motion – and just so we can find the damn things) – it is convenient to pretend that celestial objects lie on the surface of a sphere. In other words, for these limited purposes, we can ignore the actual distances of such objects.

It is also convenient to pretend that the observer (or the Earth) remains fixed and the **celestial sphere** (or “sky”) rotates. Please be assured that we do not actually believe this, it’s just a convenient fiction.

Spherical astronomy - actually spherical trigonometry - is concerned with the accurate measurement of stellar positions. It includes such things as corrections for the distorting effects of atmospheric refraction, the aberration of starlight and the “shifts” caused by the precession and nutation of the Earth’s axis.

Co-ordinate systems and the various things which affect them are very simple in principle but, like many apparently simple things, the closer you look, the more complicated and convoluted they get. Here we will just look at a few basic principles to get an idea of some astronomically useful co-ordinate systems.

### 1.1.1 Circles

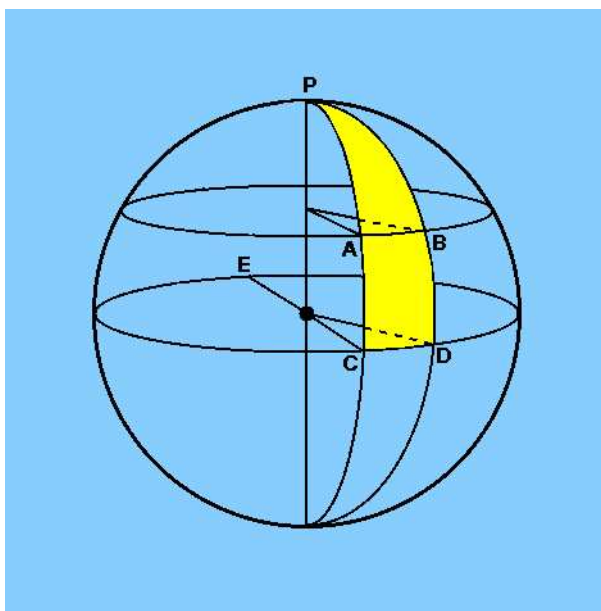

Figure 1: The circle containing CDE is a great circle; that containing AB is a small circle.

For a sphere:

- Any planar section of a sphere is a circle.
- A plane section which passes through the centre of the sphere intersects the sphere in a **great circle**,

- and any other plane intersects the sphere in a **small circle**.
- The **axis** of any great or small circle is the diameter of the sphere perpendicular to the plane of the circle,
- and the **poles** of the circle are where the axis intersects the sphere.
- **Secondaries** to any circle are great circles passing through the poles of the circle.

### 1.1.2 Example: Latitude & Longitude

Perhaps the most familiar spherical co-ordinate system is the system of **latitude** and **longitude** on the surface of the Earth.

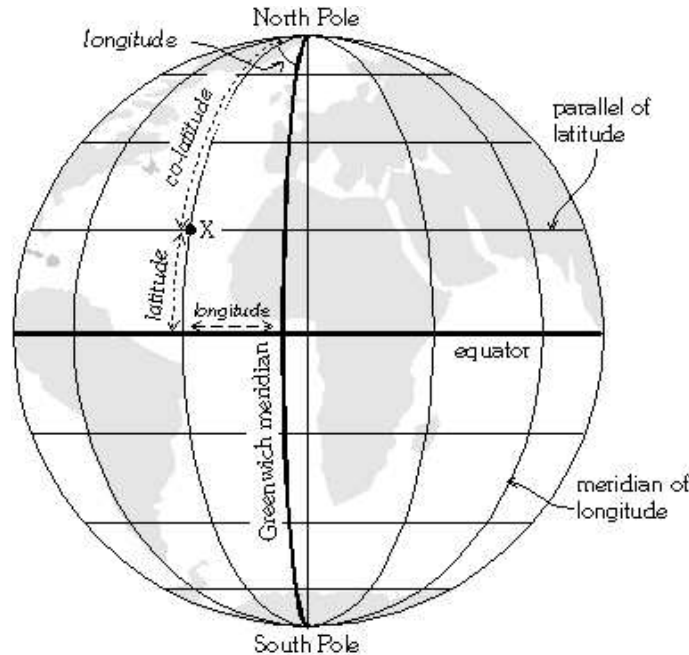

Figure 2: The terrestrial latitude and longitude system

In this case, we have:

- **The equator** – or equatorial plane – which is effectively the **fundamental plane** of the system,
- **the north and south poles** – which are the poles of the equatorial plane,
- small circles formed by planes parallel to the equatorial plane – which are the **parallels of latitude**,
- and great circles secondary to the equatorial plane which form the **meridians of longitude**.

By international agreement, the intersection of the equatorial plane with the **Greenwich meridian** (the great circle through the poles and the zenith at Greenwich) defines the zero of the system. So, latitude is measured from the equator ( $0^\circ$ ) to the north pole ( $+90^\circ$ ) or the south pole ( $-90^\circ$ )

and longitude is measured from the Greenwich meridian 180° east or west OR (since one full rotation of the Earth is 360° – which is equivalent to 24 hours) 12 hours east or west.

The astronomical spherical co-ordinate systems are all pretty much simple analogues of the terrestrial latitude and longitude system; you just have to be aware of the zero-point and to know how the equivalent to longitude is defined.

### 1.1.3 Spherical angles and triangles

The angle between two great circles is the angle between their planes. This **spherical angle** can be defined as:

- the angle between the tangents to the great circles at their points of intersection,
- the angle between their poles,
- the arc which they intercept on a great circle to which they are both secondaries.

Clearly, these definitions are all equivalent.

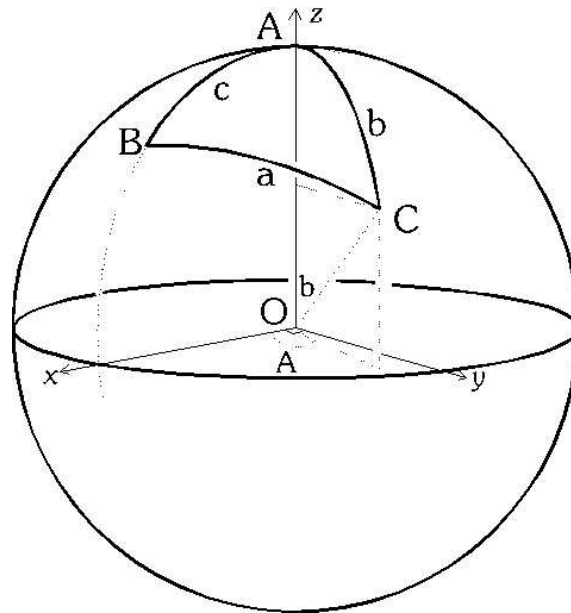

Figure 3: A spherical triangle formed by three *great circle* sides.

A **spherical triangle** is a portion of the surface of a sphere bounded by three great circles. Since a great circle is a geodesic on a sphere – the shortest distance between two points – it is analogous to a straight line on a plane and the spherical triangle is the analogue of the plane triangle.

If we chop a sphere into eight octants, it is very easy to see that a spherical triangle can have three right-angles. If we consider a very small spherical triangle, this will be almost indistinguishable from a plane triangle for which the sum of the angles is 180°. At the other limit, as the spherical triangle approaches being a great circle, all three angles will tend towards 180°, so we can write – for a spherical triangle:

$$180^\circ < (\text{sum of the angles}) < 540^\circ$$

A spherical triangle has three sides (!) and three angles, but the sides can also be expressed as the angles subtended at the centre of the sphere, so effectively the six components are expressed as angles.

A further difference between a spherical and a planar triangle is that on the surface of a sphere, a triangle is completely determined if the three angles are given (i.e. *any* three given components determine the triangle).

Various formulae can be derived for solving spherical triangles, probably the most useful are the **sine rule**:

$$\frac{\sin a}{\sin A} = \frac{\sin b}{\sin B} = \frac{\sin c}{\sin C}$$

and the **cosine rule**:

$$\cos a = \cos b \cos c + \sin b \sin c \cos A$$

(and analogous expressions for  $\cos b$  and  $\cos c$ ) which can be used to solve most problems.

Note, however, that ambiguities can occur in spherical triangles. A value  $\sin x = 0.5$  can result in  $x = 30^\circ$  or  $x = 150^\circ$ , so that a “common sense” check that the answer is sensible is even more necessary than usual.

REMEMBER THAT THE ABOVE EQUATIONS APPLY ONLY TO SPHERICAL TRIANGLES – TRIANGLES WITH SIDES WHICH ARE GREAT CIRCLES.

#### 1.1.4 Small circles

From Figure 1, note that the arcs AB and CD subtend the same angles at the polar axis. But AB is clearly shorter than CD. (Of course, ABP is *not* a spherical triangle, whereas CDP is). In general, where AB and CD lie on parallel planes, the arc AB is:

$$AB = CD \cos A\hat{\bullet}C$$

where  $\bullet$  is the centre of the sphere.

In the case of the terrestrial (latitude/longitude) system, A and C would have the same longitude and B and D would have the same longitude, but the distance AB would be given by:

$$AB = CD \cos (\text{latitude})$$

(and note that the great circle distance between A and B would be smaller than the small circle distance).

#### 1.1.5 The sky

Of course, the apparent diurnal (daily) and annual motions of celestial objects are caused by the Earth’s rotation on its axis and its orbit around the Sun respectively, But for the purposes of positional astronomy, it is convenient to regard the observer as fixed and the heavens as moving.

The **celestial poles** and the **celestial equator** are the imaginary projections on to the sky of the polar axis and equator of the Earth.

If you were located at the north (or south) pole, the celestial north (or south) pole would be directly overhead – at your **zenith** and the south (or north) pole would be directly below you

– at your **nadir**. The celestial equator would co-incide with your (flat) horizon, and you would only ever see one hemisphere of the sky.

If you were located on the equator, the celestial equator would pass through the east and west points of your horizon and your zenith and the celestial poles would be located at the north and south points on your horizon. You would be able to see the whole sky (during the course of the year).

More generally, the situation is as shown in Figure 4.

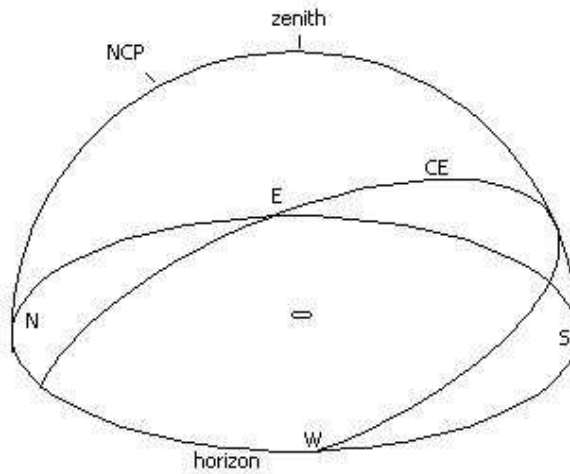

Figure 4: The sky from the northern hemisphere, alas.

The **meridian** is the great circle through the poles and the zenith and nadir. The **cardinal points** are defined by the intersection of the celestial equator with the horizon (east and west points) and by the intersection of the meridian with horizon (north and south points).

Note that the elevation of the pole – the angle between the polar axis and the horizon – is equal to the latitude ( $\phi$ ) of the observer (if you're at the south pole, the celestial pole is directly overhead; at the equator, your latitude is zero and the elevation of the celestial pole is zero – it's on the horizon).

## 1.2 Horizontal or altitude and azimuthal (“alt-az”) co-ordinates

The simplest astronomical co-ordinate system is the horizontal or “alt-az” system. For this:

- The **fundamental circle** is the **horizon**;
- the **poles** are the **zenith** and **nadir**;
- the **origin** is the north point – or at least, the intersection of the meridian with the horizon;
- the co-ordinates are:
  - **azimuth (A)** measured from the north point. Usually this is from  $0^\circ$  to  $360^\circ$  eastwards (i.e N to E to S to W) but it can also be westwards  $0^\circ$  to  $360^\circ$  or even  $0^\circ$  to  $180^\circ$  east and

west, So clearly you need to know what convention is being used in the system you're looking at;

- **altitude (a)** measured from  $0^\circ$  to  $90^\circ$  from the horizon to the zenith along a secondary great circle to the horizon.
- Sometimes **zenith distance (z)** is used, where  $z = 90^\circ - a$ . We will come across this later when correcting photometric observations for the effects of atmospheric “extinction”.

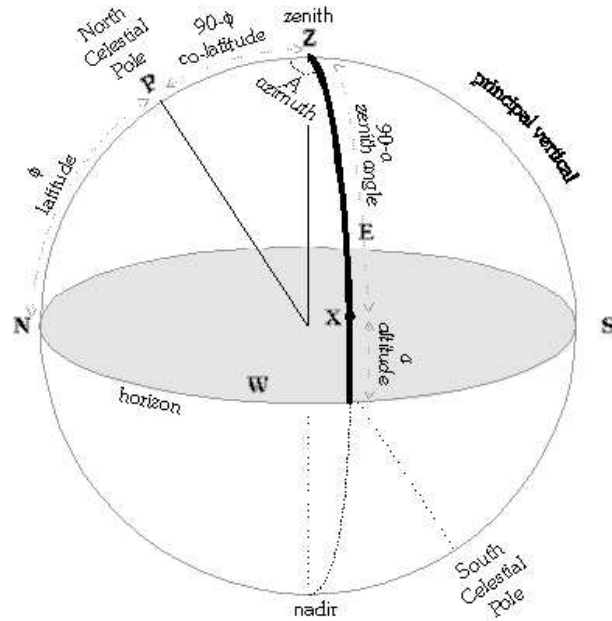

Figure 5: Horizontal or “alt-az” (altitude and azimuth) co-ordinates.

The horizontal or alt-az co-ordinates of a celestial object are both changing with time as the object rises and then sets. Consequently, they are not terribly useful for specifying the position of an object – you would have to have the co-ordinates (A,a) and know the location of the original observer as well as the date and exact time of the observation. Then you would have tedious calculations to perform to determine the location of the object on the sky at your site/date/time. On the other hand, most large telescopes are alt-az mounted (for engineering reasons) and so the co-ordinate system is very useful. It is, however, relatively simple, given an essentially time-invariant co-ordinate system, to determine the altitude and azimuth at a given location and time.

### 1.3 Hour angle and Declination (“First Equatorial”) co-ordinates

The first equatorial system is a step towards an observer-independent co-ordinate system. In this:

- The **fundamental circle** is the **celestial equator**;
- the **poles** are the **north and south celestial poles**;
- the **origin** is the intersection of the meridian with the celestial equator;
- the co-ordinates are:



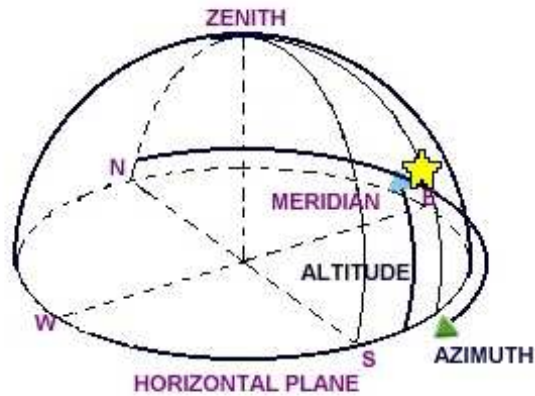

Figure 6: Horizontal or “alt-az” (altitude and azimuth) co-ordinates, measured from the North point eastwards.

- **hour angle (HA, H or h)** measured westwards from north, from  $0^\circ$  to  $360^\circ$ , though usually the time equivalent is used (0h to 24h) and often hour angle is expressed as positive west of the meridian (1h, 2h, etc) and negative east of the meridian (-1h, -2h, etc). Since the hour angle is measured from the observer’s meridian, it is a local measure and is sometimes called the **Local Hour Angle**.
- **declination ( $\delta$ )** measured from  $0^\circ$  to  $+90^\circ$  from the celestial equator to the north pole and from  $0^\circ$  to  $-90^\circ$  from the celestial equator to the south pole along a secondary great circle to the celestial equator.

Note that:

- Objects rise and set, travelling across the sky at constant declination, but travelling along *small* circles – except for objects exactly on the celestial equator.
- Objects are at their highest altitude as they cross the meridian - they are said to be at **upper transit** or **culmination**.
- The declination of a star is independent of the observer.
- A telescope on an **equatorial mount** – where one axis is aligned with the polar axis – can be set on an object at a certain declination and then driven around the polar axis (i.e. only around one axis) to track that object.

Although the Hour angle co-ordinate is not observer-independent, it is still a useful concept for some purposes.

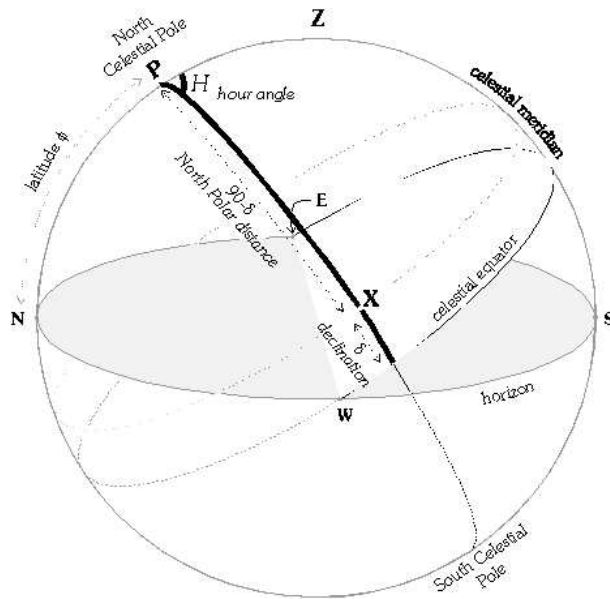

Figure 7: “First equatorial co-ordinates”: Hour angle and declination.

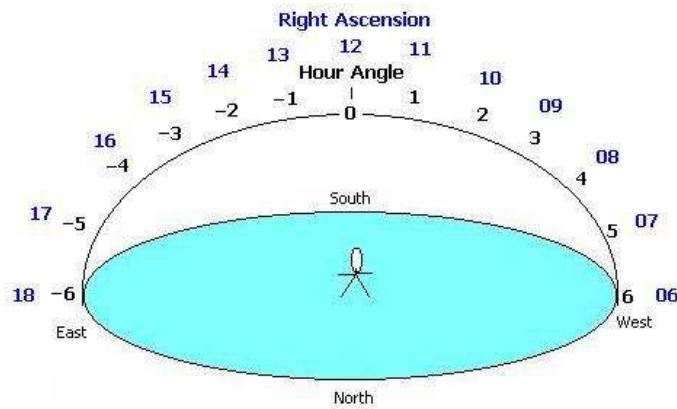

Figure 8: Hour angle

#### 1.4 Right Ascension and Declination (or “Second Equatorial”) co-ordinates

The RA and dec co-ordinate system is defined by;

- The **fundamental circle** is the **celestial equator**;
- the **poles** are the **north and south celestial poles**;
- the **origin** is the intersection of the celestial equator with the ecliptic (the apparent path of the Sun across the sky). This intersection is called the “**First point of Aries**” and also the **Vernal Equinox** or **Spring Equinox**;
- the co-ordinates are:
  - **right ascension** ( $\alpha$ ) measured eastwards from the vernal equinox, from 0h to 24h.

- **declination** ( $\delta$ ) measured from  $0^\circ$  to  $+90^\circ$  from the celestial equator to the north pole and from  $0^\circ$  to  $-90^\circ$  from the celestial equator to the south pole along a secondary great circle to the celestial equator.

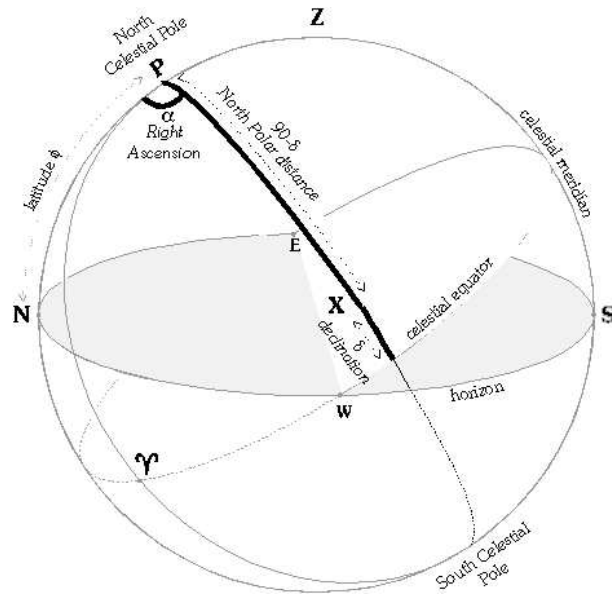

Figure 9: “Second equatorial co-ordinates”: Right ascension and declination.

The origin or zero point of this system, the vernal equinox, also takes part in the diurnal and annual motion of the stars, so that the axes of the co-ordinate system are fixed by the celestial equator and poles and provided one knows where the origin is at any time, any star can be located from its  $(\alpha, \delta)$  position.

We locate the vernal equinox using **sidereal time**.

#### 1.4.1 Sidereal time

The interval between two successive transits of a star across the meridian is one sidereal day. This is slightly shorter than the mean solar day because of the Earth’s motion around the Sun.

The sidereal day is divided into hours, minutes and seconds, in the same way as the mean solar day, but these of course are all a bit shorter than their mean solar counterparts. The sidereal day would be the measure of the true rotation period of the Earth, except that it is not actually defined by the passage of stars across the meridian, but by the passage of the first point of Aries – the vernal equinox. Due to the phenomenon of **precession**, the vernal equinox drifts by about 50 arcseconds per year. The conventionally adopted sidereal day is thus about 0.009 seconds shorter than the true period of rotation of the Earth and is about 23h 56m 4.1s.

From the point-of-view of determining star positions, 24 sidereal hours elapse between successive transits of a star across the meridian. Any given star thus completes  $360^\circ$  in 24h, so its hour angle increases at a rate of  $15^\circ$  per hour (15 arcminutes per minute; 15 arcseconds per second). The hour angle of a star is thus generally measured in elapsed units of sidereal time since the star crossed the meridian. In other words:

$$(\text{Local Hour angle of a star}) = (\text{Local Sidereal Time}) - (\text{RA of the star})$$

not to scale

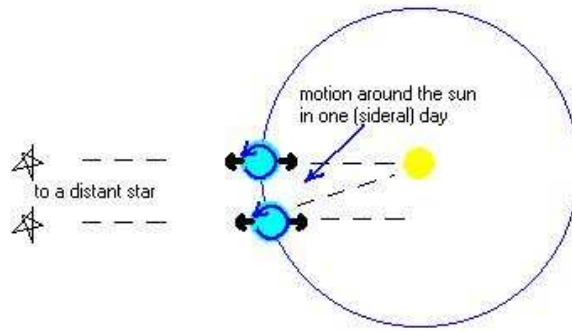

Figure 10: Sidereal time.

Note that *for a star on the meridian*, the (Local Hour angle of a star is zero, so that:

$$(\text{Local Sidereal Time}) = (\text{RA of the star})$$

In particular, the start of the sidereal day is the instant that the vernal equinox crosses the meridian – and the sidereal time is the hour angle of that point. Since the meridian is specific to the observer, we refer to sidereal time as **Local Sidereal Time**. We have defined:

$$(\text{Local Sidereal Time}) = (\text{Local Hour Angle of the Vernal Equinox})$$

**Clearly, once we have a ticking local sidereal clock, we know where the zero point of the RA co-ordinate scale is.**

There are a couple of equivalent ways of looking at the sidereal time:

- Imagine that the Earth always keeps the same face to the Sun (as the Moon does to the Earth) – the rotation period is the same as the orbital period and we say they are “phase-locked”. In this case, there will be no solar day, because the Sun will appear unmoving from any point on the Earth. But the stars will slowly drift across the sky and the sidereal day will be one year long. In other words, the orbit of the Earth around the Sun generates an extra sidereal day (compared to solar days) each year. A normal year thus contains roughly 365.25 solar days and 366.25 sidereal days, so the sidereal day is 365.25/366.25 of a solar day – which is about 23h 56m 4.1s, as noted earlier.
- Relative to the background stars, the Sun appears to move – therefore it moves in RA – by  $360^\circ/365.25\text{d}$  or a bit less than a degree per day, Since  $1\text{h} \equiv 15^\circ$ , the RA of the Sun appears to increase by a bit less than 4 arcminutes per day, We shall return to this when we look at ecliptic co-ordinates.

### 1.4.2 Conversion between horizontal and equatorial co-ordinates

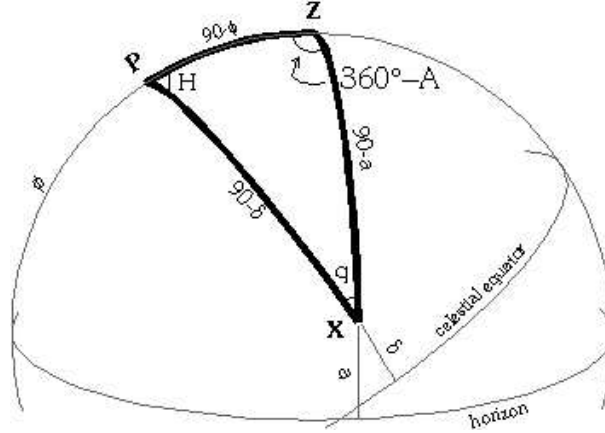

Figure 11: Spherical triangle for conversion between alt-az (H,a) and equatorial co-ordinates ( $\alpha, \delta$ ).

For a star at position X in the figure, and given the definitions of horizontal and equatorial co-ordinates, it is easy to see that the spherical triangle PZX has sides:

$PZ = 90^\circ - \phi$ , where  $\phi$  is the observer's latitude,  
 $ZX = 90^\circ - a$ , where  $a$  is the altitude of the star ((90-a) is the zenith distance,  $z$ ),  
 $PX = 90^\circ - \delta$ , where  $\delta$  is the declination of the star,  
 $Z\hat{P}X = H$ , the hour angle of the star,  
 $P\hat{Z}X = 360^\circ - A$ , where  $A$  is the azimuth of the star,  
 $P\hat{X}Z =$  is called the **parallactic angle** (nothing to do with parallax).

Applying the cosine rule:

$$\cos(90 - a) = \cos(90 - \delta) \cos(90 - \phi) + \sin(90 - \delta) \sin(90 - \phi) \cos(H)$$

so:

$$\sin a = \sin \delta \sin \phi + \cos \delta \cos \phi \cos H$$

Applying the sine rule:

$$\frac{\sin(360 - A)}{\sin(90 - \delta)} = \frac{\sin(H)}{\sin(90 - a)}$$

so:

$$\sin A = - \frac{\sin H \cos \delta}{\cos a}$$

or an expression for  $\cos A$  can be derived from the cosine rule. And similar expressions can be derived for the inverse problem – finding the equatorial co-ordinates knowing altitude, azimuth, latitude and LST.

Thus (for example) knowing the latitude  $\phi$  of the observatory, the position ( $\alpha, \delta$ ) of a star, and the hour angle  $H$  (from Local Sidereal Time) one can compute continuously the altitude and azimuth of the star to track it with a alt-az mounted telescope.

## 1.5 Ecliptic co-ordinates

Because the Earth's axis is tilted with respect to its orbital plane, we get seasons. The differences in average temperatures throughout the year being largely due to;

- the Sun's meridian altitude (and the resulting projection effect)
- the length of the day

both of which are a maximum in summer and minimum in winter. There are, of course, many other effects which affect both the mean seasonal temperatures and variations from day to day and place to place. For example:

- the atmosphere (eg. cloudy or clear),
- the geographical altitude
- proximity to the sea
- ocean currents

and so on. So, for example, Edinburgh (in Scotland) – which is further north than either Moscow or Chicago – has cooler summers and milder winters than either, because (a) the British Isles are surrounded by sea, the heat capacity of which has a “damping” effect on temperature fluctuations, whereas Moscow and Chicago are in large continents, far from the sea, and (b) Britain is significantly warmed all year round by the Atlantic current known as the Gulf stream.

From the astronomical point-of-view, however, the tilt of the Earth's axis causes the RA of the Sun to vary between  $+23^{\circ}26'$  and  $-23^{\circ}26'$  during the course of a year.

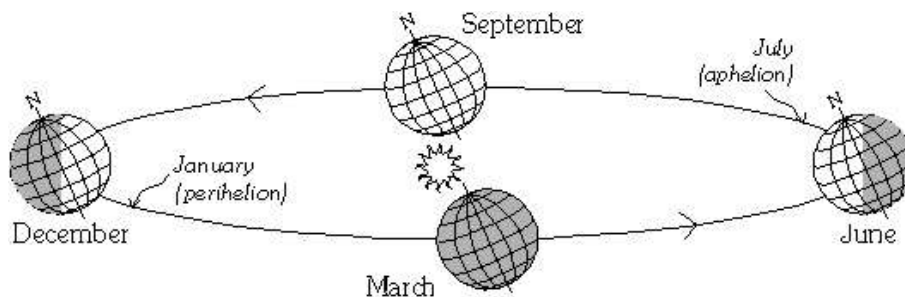

Figure 12: The Earth's orbit around the Sun.

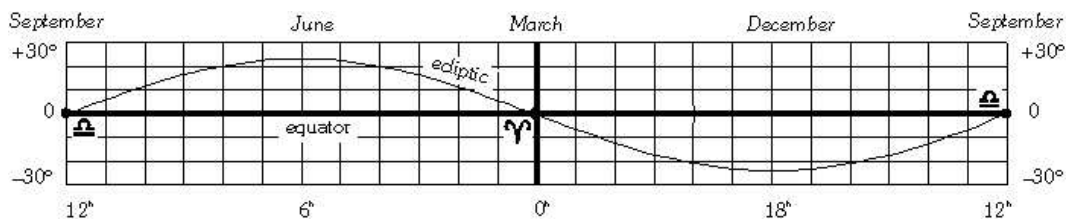

Figure 13: The ecliptic relative to RA/dec co-ordinates.

We have already seen that the Sun moves in RA such that the RA increases by a bit less than a degree per day, as a result of the Earth's orbit around the Sun. This, coupled with the declination

change due to the tilt of the Earth's axis, results in the Sun following the path in the sky indicated in the figure. This path is called the **ecliptic**.

Of course, the ecliptic is just the intersection of the plane of the Earth's orbit around the Sun with the celestial sphere. The angle of the tilt of the Earth's rotation axis (the polar axis) to the pole of the ecliptic ( $23^{\circ}26'$ ) – which is also the angle between the plane of the celestial equator and the ecliptic plane – is known as the **obliquity of the ecliptic** and is usually written  $\epsilon$

The ecliptic co-ordinate system is defined by;

- The **fundamental circle** is the **ecliptic**;
- the **poles** are the **north and south ecliptic poles**;
- the **origin** is the intersection of the celestial equator with the ecliptic, the **Vernal Equinox**
- the co-ordinates are:
  - **ecliptic (or celestial) longitude** ( $\lambda$ ) measured eastwards from the vernal equinox, from  $0^{\circ}$  to  $360^{\circ}$ .
  - **ecliptic (or celestial) latitude** ( $\beta$ ) measured from  $0^{\circ}$  to  $+90^{\circ}$  from the ecliptic to the north ecliptic pole and from  $0^{\circ}$  to  $-90^{\circ}$  from the ecliptic to the south ecliptic pole along a secondary great circle to the ecliptic.

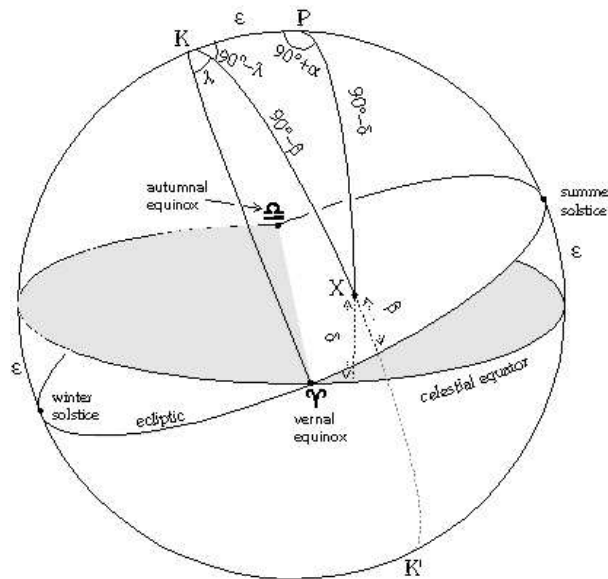

Figure 14: Ecliptic co-ordinates  $(\lambda, \beta)$ .

Any two great circles intersect in two **nodes**. Where the Sun crosses the celestial equator (south to north) is the **ascending node** which has also been defined as the **vernal (or spring) equinox** where the RA = 0h. The **descending node** is the **autumnal equinox** where RA = 12h (these are as seen from the northern hemisphere, of course !). When the Sun is at an equinox (meaning

“equal night”) the Sun is on the equator and the length of day and night are the same, The summer and winter **soltices** are when the Sun is at extrema of declination (RA = 6h and 18h). 2000 years ago, the vernal and autumnal equinoxes were in the constellations Aries and Libra. Precession has moved these points, but the names have stuck and the astrological symbols for the constellations are still used for the equinoctial points.

Clearly the apparent path of the Sun through the sky is very simple in ecliptic co-ordinates. Also, the motions of the Moon and planets are typically close to the ecliptic, so that ecliptic co-ordinates are mainly used for solar system objects.

Conversion equations between equatorial and ecliptic co-ordinates can be derived in an analogous way to the conversions between horizontal and equatorial co-ordinates, using spherical triangle KPX in the figure.

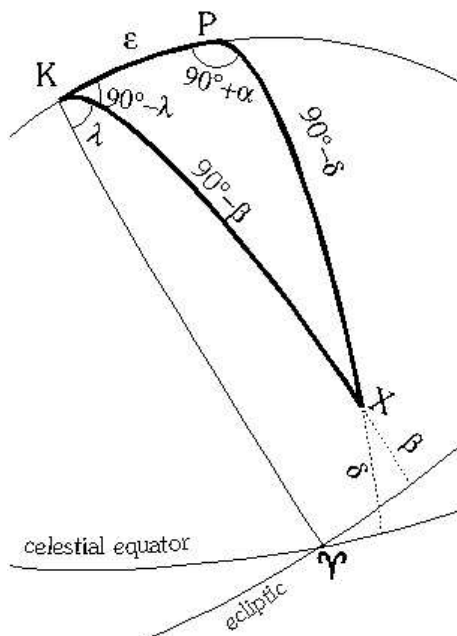

Figure 15: Spherical triangle for the conversion of ecliptic  $(\lambda, \beta)$  and equatorial co-ordinates  $(\alpha, \delta)$ .

## 1.6 Galactic co-ordinates

Galactic co-ordinates are based on the galactic plane (some kind of median plane of the disk of the Galaxy) and the direction of the galactic centre. The “best” position for the location of the poles and the galactic centre were fixed by the International Astronomical Union (IAU) in 1959. In fact, there was a galactic co-ordinate system before that date - based on somewhat different poles and galactic centre and for an “interim” period, both systems were in use and **galactic latitude and longitude** were represented by  $(l^I, b^I)$  and  $(l^{II}, b^{II})$ . Now, these quantities are represented by  $(l, b)$ , where these co-ordinates are identical to  $(l^{II}, b^{II})$ .

Galactic co-ordinates are very useful (for example) when we are interested in investigating the galactic distribution of sources, galactic structure or galactic kinematics.

The galactic co-ordinate system is defined by;



- The **fundamental circle** is the **galactic plane**;
- the **poles** are the **north and south galactic poles**. The galactic north pole is at about  $\alpha = 12^h 51.4^m$ ,  $\delta = +27^\circ 07'$  (2000.0 co-ordinates);
- the **origin** is the **direction of the Galactic centre**
- the co-ordinates are:
  - **galactic longitude** ( $l$ ) measured eastwards along the galactic equator, from the galactic centre, from  $0^\circ$  to  $360^\circ$ .
  - **galactic latitude** ( $b$ ) measured from  $0^\circ$  to  $+90^\circ$  from the galactic equator to the north galactic pole and from  $0^\circ$  to  $-90^\circ$  from the galactic equator to the south galactic pole along a secondary great circle to the galactic plane.

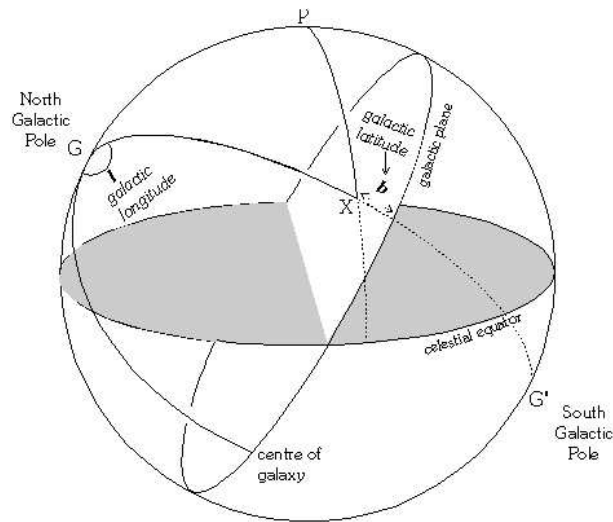

Figure 16: Galactic co-ordinates ( $l, b$ ).

## 2 Effects on apparent celestial positions

A number of different effects can alter the apparent positions of stars by small amounts:

- on a long time-scale (such as precession and nutation);
- on an annual basis (aberration and parallax);
- “locally” (atmospheric refraction);
- or in a secular way (proper motion).

As we shall see, precession and nutation actually change the co-ordinate system slightly over long time periods; aberration and parallax change the apparent position of stars (due to the Earth’s motion around the Sun; the “local” effect of refraction is dependent on the zenith distance of an object; and the proper motion of a star (the component perpendicular to the line-of-sight of it’s real motion or **space motion**) changes the actual position of a star on the celestial sphere.

## 2.1 Precession and Nutation

Treated rigorously, this is a very complicated process, caused by the gravitational effects of principally the Moon and Sun (but also the planets) on the slightly non-spherical shape of the rotating Earth. Here we look at it in a simplified, descriptive way.

### 2.1.1 Luni-solar precession

Around 125 BC, the Greek **Hipparchus** measured the celestial latitudes and longitudes of a number of stars and compared his results to results from 150 years earlier. He found the celestial latitudes essentially unchanged, but the celestial longitudes had all increased by about  $2^\circ$  or about 50 arcseconds per year.

Hipparchus correctly deduced that the equinoxes were drifting in the direction of decreasing longitude. This is the **Precession of the equinoxes** – now more usually called the **Luni-solar precession** or just **precession**. The currently accepted value is  $50.35''$  per year, so we can write:

$$\text{Precessional period} = \frac{360 \times 60 \times 60}{50.35} \simeq 25740 \text{ years}$$

Precession occurs because:

- the Earth is rotating,
- the Earth is not exactly spherical; it has a slight equatorial bulge,
- the gravitational fields of the Moon, Sun and planets affect the above.

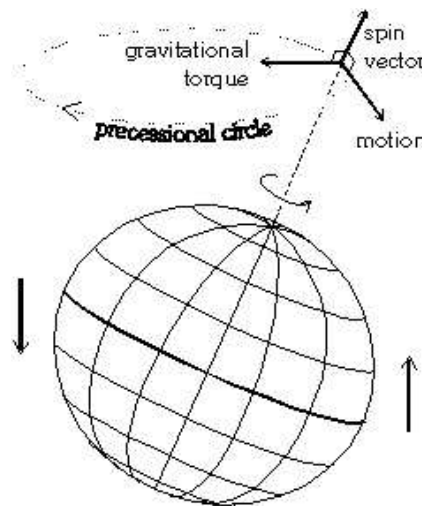

Figure 17: The precession of the Earth's axis.

The gravitational fields of principally the Moon and Sun produce a torque on the equatorial bulge tending to pull it towards the ecliptic. Because the Earth is spinning, the resultant force moves the axis of rotation in a **precessional circle** around the pole of the ecliptic – with the precessional period.

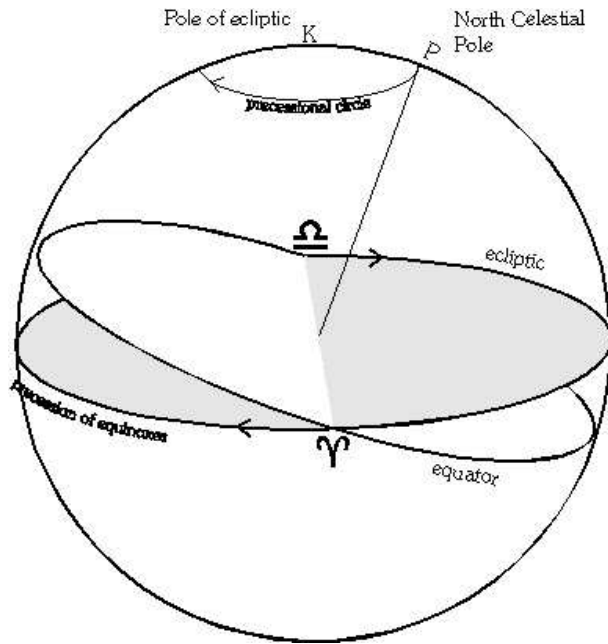

Figure 18: The precession of the Earth's axis.

### 2.1.2 Planetary precession

Planetary precession has a similar longitude effect to luni-solar precession but much smaller in amplitude ( $\sim 0.13''$ ) – and actually in the opposite direction. Planetary precession also has a small effect on the Earth's orbital plane, resulting in a slight shift in the ecliptic itself (i.e. perpendicular to the main effect of luni-solar precession which is in longitude).

Luni-solar and planetary precession together are known as **general precession** and produce changes in celestial longitude and latitude and therefore in Right Ascension and declination. Of course, the stars are not actually changing position – essentially the definition of the co-ordinate systems are changing. This is something of a nuisance but can be relatively simply corrected.

**The effects of precession mean that when quoting or using equatorial co-ordinates (for example when pointing a telescope at a star) it is important to know the epoch of the co-ordinates.** Co-ordinates will therefore usually appear with an attached date – often 1950.0 or 2000.0.

### 2.1.3 Nutation

The Moon's orbit around the Earth is slightly non-circular and the nodes of the orbit also precess with a period of about 18.6 years. In addition, the plane of the Moon's orbit is inclined at about  $5^\circ$  to the ecliptic. These factors introduce a small variable component into the luni-solar precession which results in **nutation** (literally “nodding”). A very small elliptic variation (amplitude of a few arcseconds) is superimposed on the precessional variation.

Nutation can be thought of as a second order correction to precession. Whilst in practice, the dominant effects are due to the Moon, in any kind of detail, it is immensely complicated – the currently “standard” theory of nutation contains 106 non-harmonically-related sine and cosine components, mainly due to torque effects from the Moon and Sun, plus 85 planetary corrections. The four dominant periods in nutation are 18.6 years, half a year (182.6 days), half a month (13.7

days) and 9.3 years. The figures give some idea of the complexity.

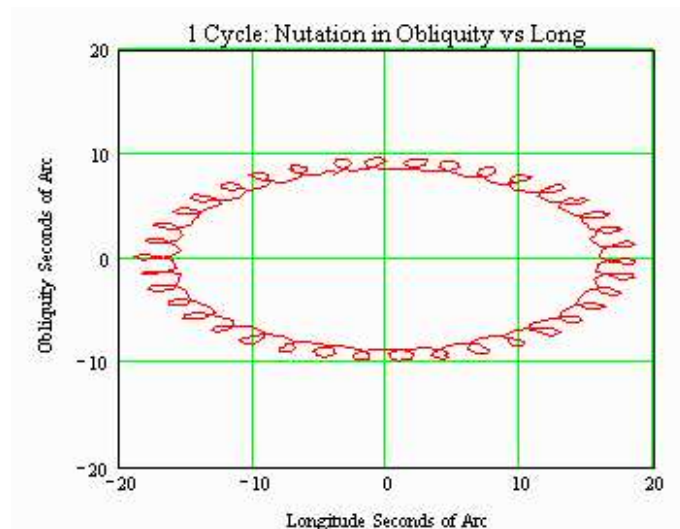

Figure 19: Nutation of the Earth's axis.

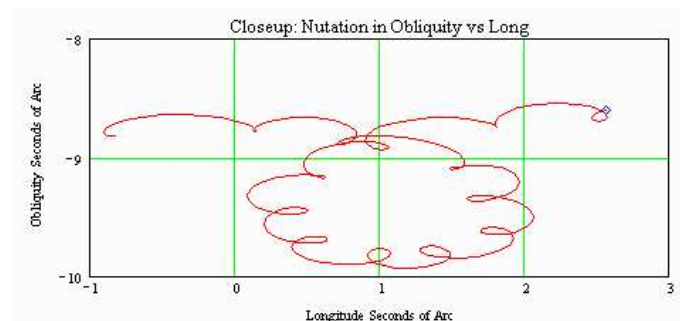

Figure 20: Detail of nutation.

## 2.2 Parallax

The phenomenon of parallax is easily understood. Close one eye and look out of the window; note the position of some distant object relative to the window frame. Open the closed eye and close the open eye – the window frame will appear to have moved relative to the distant object. It's just a matter of viewpoint.

### 2.2.1 Geocentric or diurnal (daily) parallax

For stars, distances are so large that it doesn't really matter from where on the surface of the Earth you observe them, they're effectively in the same direction. For solar system objects however, this is not the case. The **angle of parallax** can be quite significant (see figure) and to avoid having to specify a place of observation, the positions of the Sun, Moon and planets are usually given in **geocentric** co-ordinates - that is, the co-ordinates as seen from the centre of the Earth, rather than **topocentric** – as seen from a given place on the surface of the Earth.

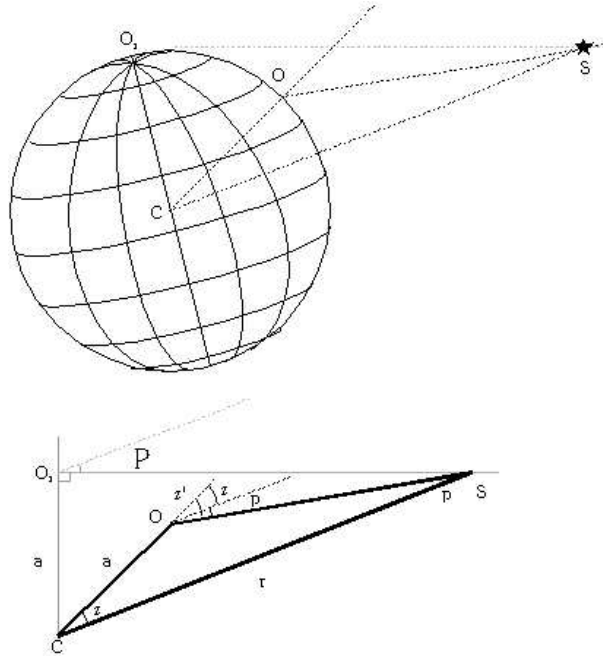

Figure 21: Geocentric or diurnal parallax.

Diurnal parallax varies with the daily rotation of the Earth. From plane triangle OCS in the figure,  $z$  is the “true” zenith distance of object S (as seen from the centre of the Earth),  $z'$  is the apparent zenith distance (as seen from O, on the surface). Then

$$\text{The angle of parallax } p = z - z'$$

or **the apparent zenith distance is increased over the true zenith distance by the geocentric parallax**. The azimuth is unaffected by parallax. If  $a$  is the radius of the Earth and  $r$  is the geocentric distance of the object, then:

$$\sin p = \frac{a}{r \sin z'}$$

Parallax is a maximum when an object appears to be on the horizon ( $O_1$  in the figure). In this case, the **horizontal parallax, P**, is given by:

$$\sin P = \frac{a}{r}$$

and generally

$$\sin p = \sin P \sin z'$$

or, since  $p$  and  $P$  are small:

$$p = P \sin z'$$

The Moon has a horizontal parallax of nearly a degree (which, paradoxically, can make it difficult to locate with a telescope if you have only geocentric co-ordinates !)

### 2.2.2 Annual parallax

Annual parallax is caused by the Earth's rotation about the Sun and is significant (detectable) for nearby stars – but no star has an annual parallax greater than 1 arcsecond.

The annual parallax of a star – or the **stellar parallax** is defined as the angle subtended at the star by the Earth's **radius**. From the figure, clearly:

$$\frac{a}{r} = \tan \pi = \pi$$

because  $\pi$  is always very small.

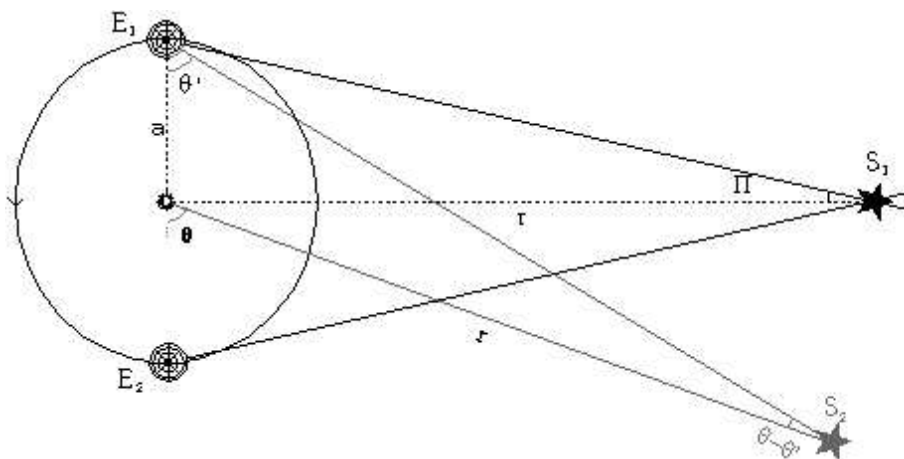

Figure 22: Annual (or stellar) parallax.

The **mean** Earth-Sun distance is called the **astronomical unit (AU)** and is roughly 149 597 871 km. If we define a **parsec** as the distance of an object with a parallax of 1 arcsecond, then with our baseline of 1 (AU):

$$\frac{1}{r (pc)} = \pi (arcsec)$$

and since no star has been observed with a parallax greater than 1 arcsecond, all known stars must be more distant than 1 parsec.

The effect of annual parallax is that for stars in the plane of the ecliptic, a nearby star will appear to move one way and then the other along a line in the ecliptic. A star at the ecliptic poles will describe a circle (with radius equal to the parallax of the star), but generally a star describes an ellipse with semi-major axis equal to the stellar parallax.

As we have seen, annual parallax does not have a large effect on celestial positions. However, annual parallax is fundamental to astrophysics as the first step in determining distances. we shall return to this later.

### 2.3 Proper motion

The **proper motion** of a star is simply that part of the **space motion** of the star which is perpendicular to the line-of-sight. This results from the motion of the star relative to the Sun (which is itself orbiting the galactic centre at more than 200 km/sec).

The part of the space motion along the line-of-sight is called the **radial velocity** and has no

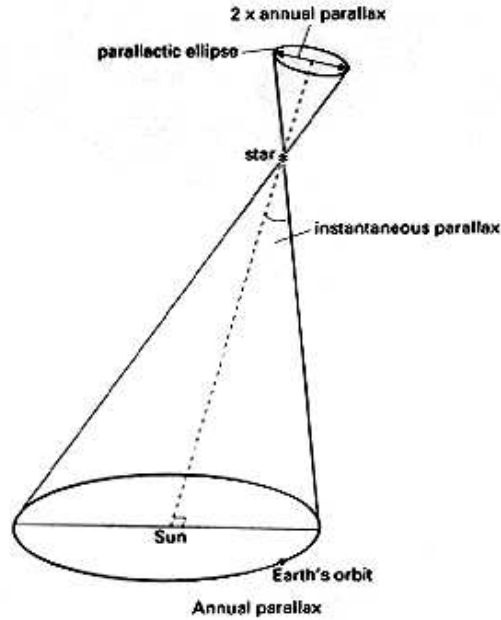

Figure 23: Parallactic ellipse (for general position of a star).

effect on the apparent position of a celestial body. Radial velocity is measured by the Doppler shift of spectral features.

## 2.4 The aberration of starlight

Aberration is also due to the Earth's motion and has a somewhat similar effect to annual parallax. By the early 1700's a number of attempts had been made to detect stellar parallax. An attempt by Bradley in 1727 detected displacement in  $\gamma$  Dra but in a different sense than expected from parallax. Bradley eventually realised the cause of the displacement was **stellar aberration**.

The usual analogy for aberration is that if you stand still in the rain, raindrops appear to fall vertically; if you walk, the raindrops appear to fall at a slight angle towards you. If the Earth's linear velocity is  $v$ , whilst light travels a distance  $ct$  down the telescope, the Earth (and the telescope) travels a distance  $vt$ .

From the figure,  $\theta$  is the direction of the star relative to the Earth's motion, and  $\theta'$  is the apparent direction of the star (changed by aberration) – a smaller angle.

From the triangle (and writing  $\Delta\theta = \theta - \theta'$ ), the observed displacement  $\Delta\theta$  is given by:

$$\frac{\sin \Delta\theta}{vt} = \frac{\sin \theta'}{ct}$$

so

$$\sin \Delta\theta = \frac{v}{c} \sin \theta' = \frac{v}{c} \sin (\theta - \Delta\theta)$$

and

$$\sin \Delta\theta = \frac{v}{c} (\sin \theta \cos \Delta\theta - \cos \theta \sin \Delta\theta)$$

Dividing by  $\cos \Delta\theta$  and shuffling things around gives

$$\tan \Delta\theta = \frac{v}{c} \sin \theta (1 + \frac{v}{c} \cos \theta)^{-1}$$

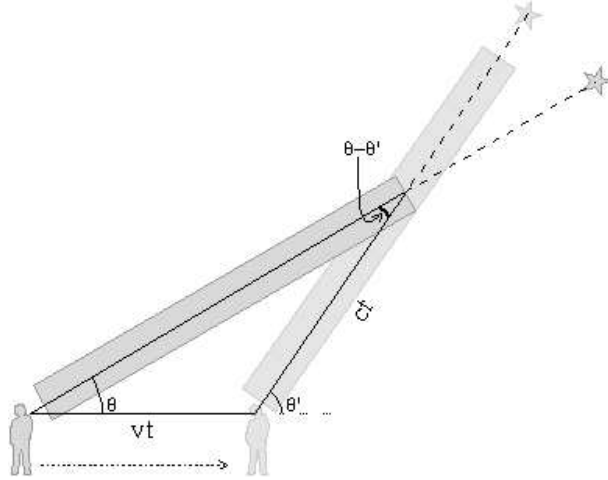

Figure 24: The aberration of starlight. (Note: angle  $\theta$  should be  $\theta'$  and vice versa).

since  $\Delta\theta$  is always small, we can write  $\tan \Delta\theta = \Delta\theta$ , and expand the right-hand bracket, so

$$\Delta\theta = \frac{v}{c} \sin \theta - \frac{1}{2} \left(\frac{v}{c}\right)^2 \sin 2\theta + \dots$$

This, of course, is the classical theory; the relativistic derivation gives the same first two terms. But, in practice, since the Earth's velocity is only a ten thousandth of the velocity of light, only the first term is usually relevant to us, and we can write

$$\Delta\theta = \frac{v}{c} \sin \theta = k \sin \theta$$

where  $k$  is the **constant of annual aberration**. This can be measured, but can also be calculated from

$$k = \frac{v}{c} = \frac{2\pi (\text{Radius of Earth's orbit})}{\text{Period of Earth's orbit (year)} \times c}$$

so

$$k = \frac{2\pi (1.5 \times 10^{13})}{(31.56 \times 10^6)(3 \times 10^{10})} \text{ radians}$$

$$k = \frac{2\pi (1.5 \times 10^{13}) \times 206265}{(31.56 \times 10^6)(3 \times 10^{10})} \text{ arcseconds}$$

and

$$\mathbf{k = 20.47 \text{ arcseconds}}$$

Of course, the Earth's axial rotation also has an effect and we can derive  $v/c$  for this from

$$k_d = \frac{v}{c} = \frac{2\pi (\text{Radius of Earth}) \cos(\text{latitude of observer}) \times 206265}{\text{Sidereal Day} \times c}$$

and

$$\mathbf{k_d = 0.32 \text{ arcseconds}}$$



The effect of annual aberration is that all stars appear to describe an ellipse on the sky during the course of the year. The semi-major axis of the ellipse is  $k$ , the constant of annual aberration, and the semi-minor axis is  $k \sin \beta$ , where  $\beta$  is the celestial latitude of the object.

#### 2.4.1 Comparison between the effects of parallax and aberration

The general effects of parallax and stellar aberration are similar – both cause a departure of the observed position from the true position which follows an ellipse throughout a year.

Differences are:

- The ellipses are  $90^\circ$  out of phase – the phase of aberration is the same as the parallax phase would have been 3 months earlier.
- The effect of aberration is much bigger;  $k = 20.47$  arcseconds, whereas stellar parallax is always less than 1 arcsecond.
- The effect of aberration is the same for all stars – it is defined only by the Earth’s motion around the Sun – whereas the effect of parallax also depends on the distance of each star. This means that nearby stars can readily be seen moving relative to “background” stars. In the case of aberration, stars in a small field will show no **relative** motion.

## 2.5 Atmospheric refraction

The effect of refraction in the atmosphere shifts the observed position of a star towards the observer’s zenith, so it is an effect specific to a given location (rather than being dependent on the Earth’s position in its orbit, for example).

Assume that the atmosphere can be represented by a series of homogeneous layers, increasing in refractive index ( $\mu$ ) towards the ground.

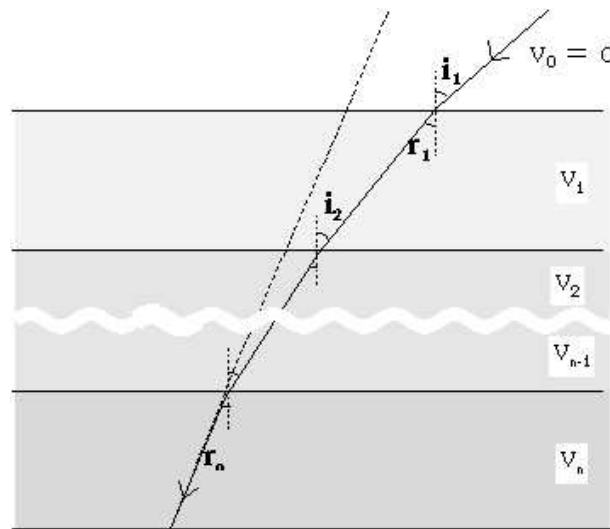

Figure 25: Atmospheric refraction.

Snell's law of refraction gives (see the figure):

$$\mu_0 \sin i_1 = \mu_1 \sin r_1$$

$$\mu_1 \sin i_2 = \mu_2 \sin r_2$$

and so on. Since  $r_1 = i_2$ , we can write:

$$\mu_0 \sin i_1 = \mu_1 \sin r_1$$

$$\mu_1 \sin r_1 = \mu_2 \sin r_2$$

$$\mu_2 \sin r_2 = \mu_3 \sin r_3$$

to

$$\mu_{n-1} \sin r_{n-1} = \mu_n \sin r_n$$

and almost everything cancels out, leaving:

$$\mu_0 \sin i_1 = \mu_n \sin r_n$$

Since  $\mu_0$  is the refractive index of vacuum ( $= 1$ ) and we can write  $\mu_n = \mu$  (the refractive index at ground level),  $i_1 = z_t$  (the true zenith distance of the star), and  $r_n = z_o$  (the observed zenith distance of the star):

$$\sin z_t = \mu \sin z_o$$

If the **angle of refraction**,  $R = z_t - z_o$ , then:

$$z_t = R + z_o$$

and

$$\sin (R + z_o) = \mu \sin z_o$$

so

$$\sin z_o \cos R + \cos z_o \sin R = \mu \sin z_o$$

Since  $R$  is very small, we can write  $\cos R = 1$  and  $\sin R = R$ , so:

$$\sin z_o + R \cos z_o = \mu \sin z_o$$

$$R = (\mu - 1) \tan z_o \text{ radians}$$

or

$$R = 206265 (\mu - 1) \tan z_o \text{ arcseconds}$$

equivalent to

$$R = k \tan z_o$$

$\mu$  (and therefore  $k$ ) depends on air temperature and barometric pressure at the time of observation. At standard temperature ( $273^\circ K$ ) and pressure (1000 millibars),  $k$  is about 59.6 arcseconds. The

Astronomical Almanac gives the following formula for deriving  $k$  for other values of temperature and pressure:

$$k = \frac{16.27 \times P(\text{millibars})}{273 + T^{\circ}C}$$

One easily seen effect of refraction is that the Sun appears “squashed” when on or near the horizon. This is because refraction displaces the bottom edge of the Sun by a greater amount towards the zenith than the top edge.

It also means that objects rise sooner and set later than would be expected from positional calculations alone.



Figure 26: The effect of atmospheric refraction on the solar disc – obvious because the Sun is right on the horizon.

## 2.6 Atmospheric dispersion

Atmospheric dispersion has little effect on the position of stars, but is essentially a result of refraction and so is briefly described here. The refractive index of any medium is a function of wavelength. In the case of air, this is shown in the figure.

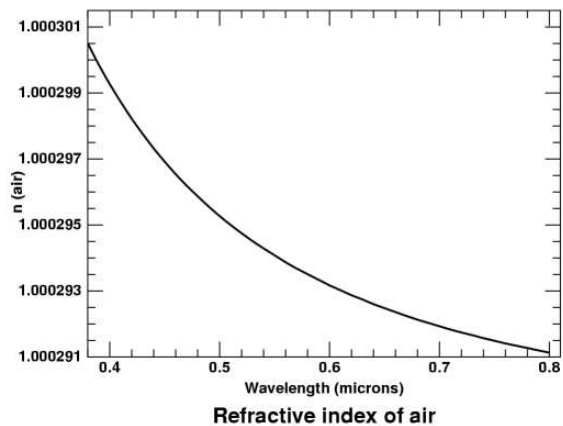

Figure 27:

The effect that this has is to refract blue light more than red light. For stars at significant zenith distances, the **atmospheric dispersion** forms a small spectrum of the star image (see figure). This can be a problem, for example, when keeping a star image on a spectrograph slit. Suppose that a red-sensitive CCD were used to set a star image on the slit, but that blue light was required in the spectrograph. In this example it is possible to “miss” the star altogether.

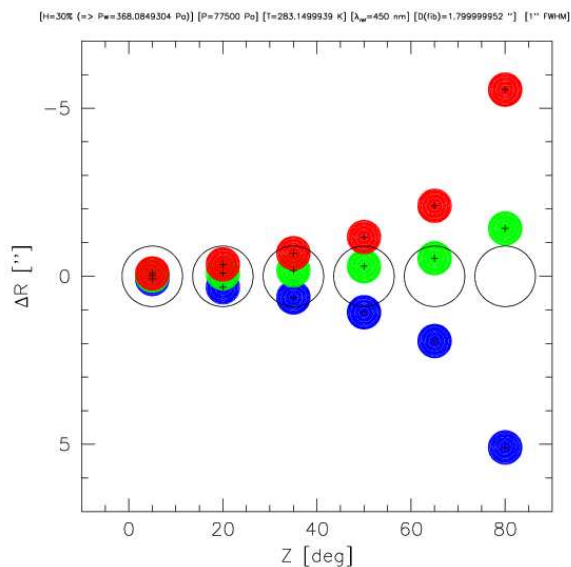

Figure 28: Schematic of the effect of atmospheric dispersion.  $z$  is the zenith distance of the star ( $90^\circ - \text{altitude}$ ). The positions of images at 350, 500 and 920 nm, relative to 450 nm.

One solution is to set the spectrograph slit so that the atmospheric dispersion is along the slit. For a long exposure, this might mean continuously rotating the slit during the exposure. It obviously helps to keep exposures short (though this might not be possible) and to make observations as near to the zenith as possible.

Various Atmospheric Dispersion Correctors (ADC) are in existence. The simple solution is to put a prism in the beam to counter the atmospheric dispersion. A simple prism would deviate light from the optic axis, so an **Amici prism** is used. This is a two prisms of the same angle but differing refractive indices, cemented together forming an optical element in which the outer surfaces are parallel, and which leaves light of intermediate wavelengths undeviated while light of longer and shorter wavelength are deviated so as to correct for the atmospheric dispersion.

To allow for the system to be tuned for different zenith distance, two prisms can be used; when in opposite orientation, these give zero dispersion, when in the same orientation they give twice the dispersion of a single unit.

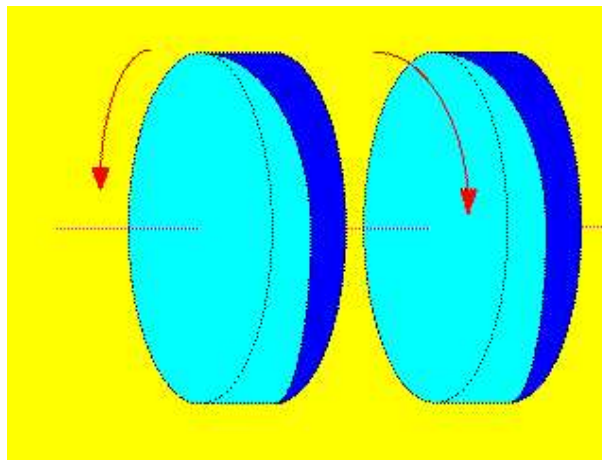

Figure 29: Schematic of double Amici prism set up for correcting atmospheric dispersion.